

ASTRO Digital SABER Series

Parts List

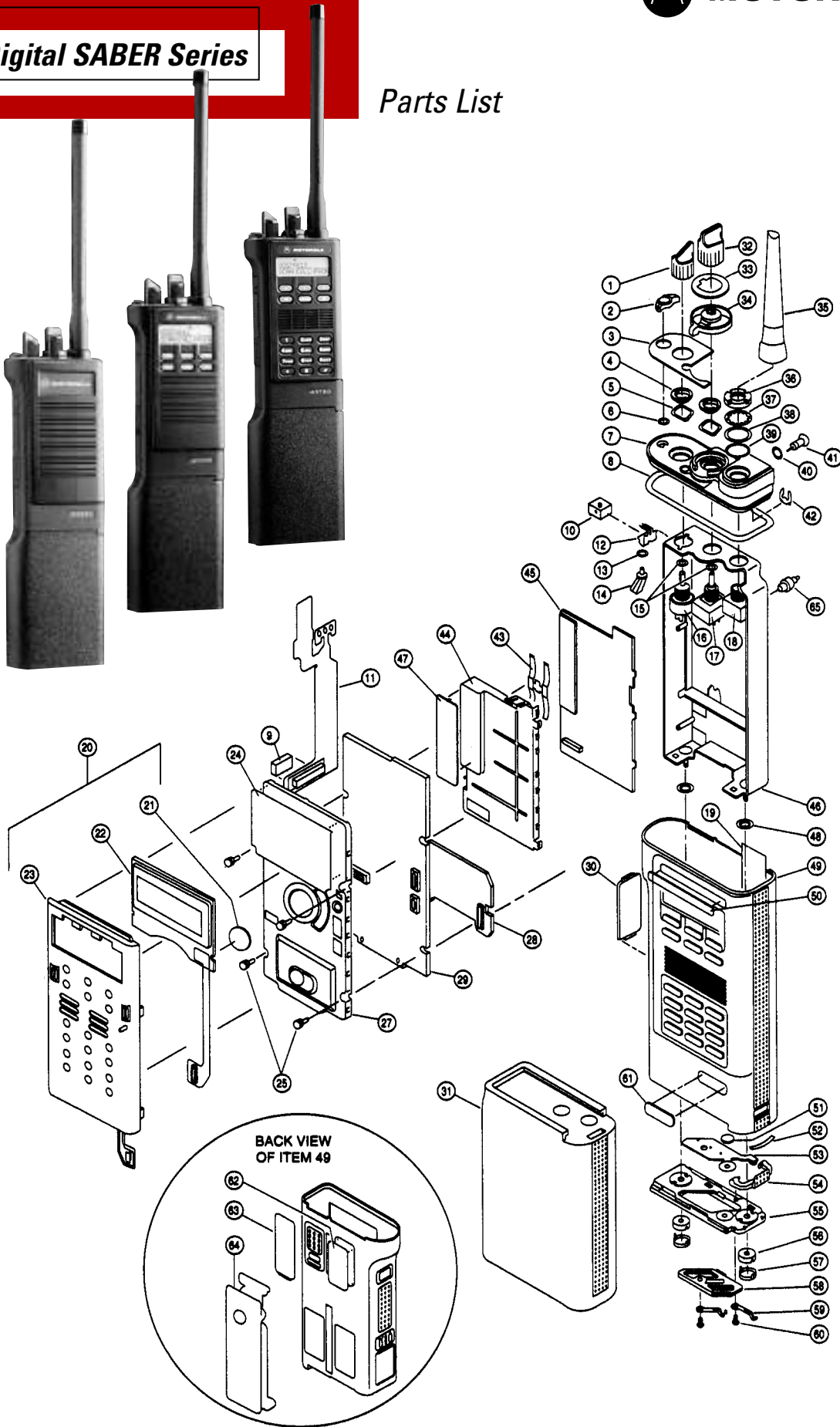

ASTRO Digital SABER Series

Parts List

REF. NO.	PART NO.	DESCRIPTION
1	3602631J06	Knob, On/Off/Volume
2	NTN5068A	Kit, Programmable Button and Switch; includes item 6
3	1302647J01	Escutcheon
4	0205163Q02	Nut, Spanner (2 req'd)
5	0402838X01	Washer, Special (2 req'd)
6	----	"O" Ring, Switch; part of item 2 – not available
7	6402641J04	Control Top
8	3205082E80	"O" Ring, Control Top
9	7505501R04	Pad
10	4005221R03	Switch, Top Button
11	8402805X04	Flex, Control Top/PTT
12	0705319R02	Clip, Switch Retaining
13	3205082E61	"O" Ring, Light Pipe
14	6102638J01	Lens, Light Pipe
15	3205082E01	"O" Ring, (2 req'd)
16	1805629V03	Potentiometer, On/Off/Volume Control
17	4002622J03	Switch, Mode/Zone Selector
18	4005187W02	Switch, Antenna
19	1405182M03	Insulator, Universal Connector
20	NTN7637C	Shield, Non-Display Front (Includes items 21 and 23, not 22)
	or	
	NTN7638C	Shield, Display Front (Includes items 21 thru 23) item has been cancelled
21	1405568W01	Insulator, Speaker Magnet
22	0105950T02	Assembly, Display Board; includes Display Flex, LCD, and Display Circuit Board
23	NTN7637C	Assembly, Front Shield (includes Speaker/Microphone Flex and item 21)
24	----	Insulator, Controller Shield – not available
25	0305150X01	Screws, Controller Shield (4 req'd)
26	----	Not Used
27	2605844V02	Shield, Controller
28	----	Board Kit, Option; Typical – not available
29	NTN7749G	Board Kit, Controller
30	4505022P02	Lever, PTT
31	NTN4593DR	Battery, Medium Capacity NiCd
	or	
	NTN4595DR	Battery, Ultra-High Capacity NiCd
	or	
	NTN7014BR	Battery, Medium Capacity NiMH
32	3602632J02	Knob, Mode/Zone Selector
33	1302646J01	Escutcheon
34	4502640J01	Lever, Switch
35	8505518V01	Antenna, VHF Wide-Band Helical (136-174 MHz)
	or	
	8505644V01	Antenna, VHF Helical (136-151 MHz)
	or	
	8505644V02	Antenna, VHF Helical (151-162 MHz)
	or	

REF. NO.	PART NO.	DESCRIPTION
	8505644V03	Antenna, VHF Helical (162-174 MHz)
	or	
	8505644V04	Antenna, UHF Helical (403-435 MHz)
	or	
	8505644V05	Antenna, UHF Helical (435-470 MHz)
	or	
	8505644V06	Antenna, UHF Helical (470-512 MHz)
	or	
	8505241U05	Antenna, UHF Wide-Band Whip (403-512 MHz)
	or	
	8505241U03	Antenna, 800 MHz Whip
	or	
	NAF4000B	Antenna, 800 MHz Dipole
	or	
	8505241U06	Antenna, 800 MHz Stubby Quarterwave
36	0205591R01	Nut, Antenna Switch
37	0400139731	Lockwasher
38	0405659W01	Washer, Antenna Switch
39	3205082E21	"O" Ring, Antenna Switch
40	3205082E59	"O" Ring, Remote Connector
41	0905702V02	Plug, External Antenna
42	4205622W04	Clip, RF Ground
43	4105875U01	Clip, PA (part of item 44) item has been cancelled
44	----	Shield, Center (includes item 43) – not available
45	NLD8892R	Board Kit, RF (VHF)
46	0105953T12	Chassis (includes 2 stud screws)
47	----	Insulator, RF Shield – not available
48	3205422Q01	Seal, Stud (2 req'd)
49	REX1105A	Housing Kit, Model I
	or	
	REX1104A	Housing Kit, Model II
	or	
	REX1103A	Housing Kit, Model III (shown) Note: housing kits include items 19, 30, 50 thru 60, 62, 67 and the Universal Flex
50	3305521W02	Label, Nameplate
51	3205472M02	Seal, Port
52	4105775Q01	Spring, Latch
53	3205783T02	Elastomer, Baseplate
54	5505333Q01	Latch, Battery
55	6405847N03	Baseplate
56	0205415Q03	Nut, Slotted Spanner (2 req'd)
57	4205416Q01	Cap, Nut Retaining (2 req'd)
58	4205669T01	Retainer, Baseplate
59	3905453Q01	Contact, Power (2 req'd)
60	0305706Q02	Screw (2 req'd)
61	3305522W01	Label, Astro
62	3305521W03	Label, FLASHport
63	NTN7061A	Kit, Universal Connector Cover
64	NTN7309A	Kit, Belt Clip
65	4505886V03	Actuator, Antenna Switch

ASTRO Digital SABER Series

Portable Accessories

Chargers

Single Unit Rapid Universal Tri-Chemistry Chargers

Tri-chemistry chargers support Nickel Cadmium, Nickel Metal Hydride, and Lithium-Ion batteries.

NTN1667A 110V Universal Charger

NTN1668A 220V Universal Charger

NTN1669A 240V Universal Charger



NTN1667A

impres™ Smart Energy System



WPLN4111AR

The impres smart energy system ensures maximum talk-time and optimized battery cycle life through the use of its advanced charging algorithm and automatic reconditioning features. The smart energy system reconditions impres batteries when they need it automatically, keeping them in peak condition. It's advanced conditioning features allow batteries to be safely left on

the charger for extended periods of time without incurring the damaging heat build-up which can rob batteries of cycle life. In addition, batteries left on the charger are kept fully charged so they are always ready when you need them. The impres system reconditions batteries when they need it based on their usage pattern. Talk time and cycle life are optimized and the need for manual maintenance programs reduced or eliminated. This rapid-rate tri-chemistry charging system will also charge existing legacy batteries and supports multiple radio platforms including Saber, XTS, and HT1000 series portables.

WPLN4108BR impres Smart Energy System Multi-Unit Charger

WPLN4109BR impres Smart Energy System Multi-Unit Charger 220V/240V

WPLN4111AR impres Smart Energy System Single-Unit Charger

5889254E01 Battery Adapter (required for batteries NTN4537, NTN4592, NTN7014 and NTN8818)

Chargers

impres™ Multi-Unit Charger with Display Modules

The impres Multi-Unit Charger with Charger Display Modules has a two-line LCD screen for each of its six charger pockets that provides users with a host of valuable battery information. When a calibrated impres battery is inserted into a pocket, it provides the current battery mAh and percent of rated capacity which allows the user to immediately know the status of the battery without having to charge and discharge the battery. Additionally, the unit displays the remaining charge time (NiCd and NiMH only) which lets the user know when the impres battery will be ready for use. Additional information displayed includes: battery serial and part number information, battery chemistry, voltage and charge status and the version of the charger and display modules.

WPLN4130AR Multi-Unit Charger with Display Modules

RLN5382A Charger Display Module for impres multi-unit charger version 1.3 or later

RLN5591A Charger Display Module for impres multi-unit charger version 1.2 or earlier



WPLN4130AR

impres™ Bundle Packs

Provide significant savings on the impres products by bundling a charger and two batteries together as a smart energy system package.

RLN5261A impres Charger with two HNN9033AR batteries

RLN5444B impres Multi-Unit Charger with six HNN9033AR Batteries

RLN5264A impres Charger with two HNN9034AR batteries

RLN5442A impres Multi-Unit Charger with six HNN9034AR Batteries

ASTRO Digital SABER Series

Portable Accessories

Motorola Conditioning Charger (MCC)

Motorola Conditioning Chargers

The MCC utilize negative pulse charging technology that will help extend battery life and enhance battery operation. It will safely condition and charge your specified NiCd and NiMH batteries in approximately an hour. The MCC controls heat buildup due to its charging and termination algorithms and maintenance mode allows batteries to be safely left on the charger for extended periods of time. And now there is an Instant Fault Detection (IFD) feature which detects faulty radio batteries in seconds, which notifies the user that the battery will not operate at peak performance. Optional accessories are available allowing these chargers to be used in both AC and DC environments providing optimal charging flexibility.

WPPN4002BR Base Charge Unit Only, 110V AC (order adapter plate separately)

WPPN4006AR Base Charge Unit Only, 220V AC (order adapter plate separately)

WPPN4001BR Adapter Only, 7V

WPLN4096AR Base 110V AC (includes Base Unit and 7V adapter)

WPPN4065BR Multi Unit Charger, 4-Station Base (order adapter plates separately)

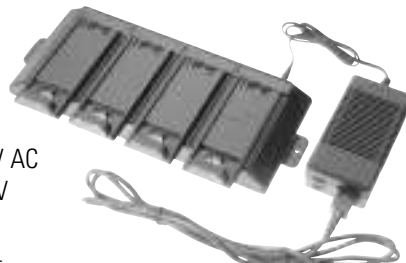

WPPN4065BR
Shown with Adapter Plates

Motorola Conditioning Charger (MCC)

3080384G15 Cigarette Lighter Adapter Cord

3080384M21 DC Hard Wire Cable, for vehicular installation (included in RLN4814A)

RLN4814A Vehicular Mounting Bracket for single unit Motorola Conditioning Charger



RLN4814A

Porta-Pocket Charger

The Porta-Pocket Charger provides a regular rate 16-hour charge to nickel cadmium (NiCd) batteries.

NTN5563B Porta-Pocket Charger, 110V AC, regular rate, includes AC power supply/cable

NKN6289A 12V DC Ignition Wiring Cable, includes dash mount bracket

NKN6290B 12V Cigarette Lighter Receptacle Cable, includes dash mount bracket



NTN5563B

ASTRO Digital SABER Series

Portable Accessories

Battery Maintenance System^{plus} (BMS^{plus})

Increase the useful life of your batteries.

Using interchangeable battery adapters (sold separately), the BMS^{plus} is capable of charging and discharging, analyzing, conditioning and cycle test on batteries; tracking battery voltage and capacity (mAh).

The BMS^{plus} offers a 3 year warranty. Its easy-to-use design supports hundreds of 2-way, cellular, and camcorder batteries with printer port* (Serial-RS-232C port – uses female 9-pin to male 25-pin cable).



WPLN4079BR

WPLN4079BR Six-Station, 110V AC, 50/60 Hz

WPLN4080BR Six-Station, 230V AC, 50/60 Hz

WPPN4085AR BMS^{plus} field Upgrade Kit or WPLN4079AR, WPLN4080AR, and WPLN4081AR; allows these units to support Li-ion battery chemistries

NDN4005B Three-Station, 110V AC 50/60 Hz (does not support Li-ion or 3-cell batteries)

NDN4006B Three-Station, 230V AC 50/60 Hz (does not support Li-ion or 3-cell batteries)

BMS^{plus} Adapters

TDN9434A NiCd Adapter, 7.5V for use with NTN7058A

WPPN4066AR NiCd and NiMH adapter, 7.5V compatible with same batteries as TDN9450A adapter plus NTN8251AR

WPPN4087AR NiCd and NiMH Adapter, 7.5V compatible with same batteries as TDN9450A adapter plus NTN8251AR

WPPN4091AR Li-ion Only Adapter

TDN9450A NiCd Adapter, 7.5V, for use with NTN4537CR, NTN4538DR, NTN4592CR, NTN4593DR, NTN4595DR, NTN4596DR and NTN4992CR

Battery Optimizing System II (BOS II)



WPLN4124AR

No other battery analyzer matches the speed, accuracy, and versatility of the Battery Optimizing System II. Ideal for large fleet, public safety, and all other users who rely on their battery performance. Now with increased power, more sophisticated programming options, and easier to use navigation paths, optimizing your batteries was never easier. Key features include:

- Support for NiCd, NiMH, Li-ion, and SLA batteries
- 100 watt power supply and programmable from 100 mAh to 4 amps per station
- Interchangeable adapters accommodate all major brands
- Includes a variety of user programs and allows for customizable programming
- Proprietary recondition cycle restores NiCd and NiMH batteries
- Increased processing power and testing resolution – including a three minute Quicktest that measures the batteries State of Health (SoH)
- Printer output for reports and labels
- Three year warranty

WPLN4124AR BOS II, Four-Station, 100-240V AC (US line cord)

WPLN4125AR BOS II, Four-Station, 100-240V AC (UK/Euro line cords)

BOS II Adapter Plates

RL-772703 Ruggedized Adapter, SABER-R

RL-71203 Standard Battery Adapter, SABER

* Compatible with the STAR Micronics SP200 series printers, available from any STAR Micronics distributor, and other printers with STAR emulation.

ASTRO Digital SABER Series

Portable Accessories

Carrying Accessories

A variety of carrying accessories are available for your comfort and convenience. The carrying cases are available in sizes designed to fit your radio and battery and permit audio to be heard clearly.

Medium Capacity Nickel Cadmium Batteries



NTN5644A

NTN5578A Leather Standard Snap Carry Case with Belt Loop (order T-Strap separately)

NTN5644A Leather Swivel Snap Carry Case (order T-strap and swivel belt loop separately)

NTN8124A High Activity Leather Swivel Snap Carry Case (order with NTN8039 for swivel belt loop and T-strap separately)

NTN7574B Nylon Standard Snap Carry Case with Belt Loop (includes T-strap)



NTN8124A

Ultra High Capacity Nickel Cadmium Batteries

NTN7572A Leather Standard Snap Carry Case with Belt Loop (order T-strap separately)



NTN7572A

NTN7573A Leather Swivel Snap Carry Case (order T-strap and swivel belt loop separately)

NTN8125A High Activity Leather Swivel Snap Carry Case (order T-strap and either NTN8039 or NTN8040 swivel belt loop separately)

NTN7391A Nylon Standard Snap Carry Case for use with ruggedized radios (includes T-strap)

NTN7847A Nylon Swivel Snap Carry Case for use with ruggedized radios with 2.5" (swivel belt loop and T-strap included)

NTN7529B Nylon Standard Snap Carry Case with Belt Loop (includes T-strap)

Carrying Accessories

T-Straps

NTN7758A Leather case T-Strap

NTN7846A Nylon case T-Strap



4282421J06

Belt Loops

4282421J06 2.5" Leather Swivel Belt Loop

4205857B01 3.0" Leather Swivel Belt Loop

High Activity Belt Loops

The below listed leather swivel belt loops are for use ONLY with the high activity leather swivel snap carry case.

NTN8039B 2.5" Leather Swivel Belt Loop

NTN8040B 3" Leather Swivel Belt Loop



NTN8039B

High Activity Button

PHN6141A Removable "D" button used in conjunction with high-activity belt loop

Belt Clip

NTN7309A Removable Belt Clip Attachment

Carrying Strap

NTN5243A Adjustable Black Carrying Strap, attaches to "D" rings on case



NTN5243A

ASTRO Digital SABER Series

Portable Accessories

Carrying Accessories

Chest Pack

HLN6602A Universal Chest Pack with Radio Holder, Pen Holder, and Velcro Secured Pocket

1505596Z02 Replacement Strap for HLN6602



HLN6602A

Break-a-Way Chest Pack



RLN4570A

All of the same features as the original chest pack (HLN6602A) plus break-a-way tabs that allow the entire pack to be pulled off with approximately 10 lbs of pressure. Perfect for railroads, manufacturing locations, construction sites and anywhere that safety is a concern.

RLN4570A Break-A-Way Chest Pack

RadioPAK™

It's different from all other holders or cases: more comfortable, more useful, and more stylish. Worn around the waist, it holds two-way, iDEN portables or cellular phones right at hand. Includes a separate 6"x8" zippered pouch for other on-the-job necessities. Adjustable nylon weave belt; fits both men and women.

RLN4815A RadioPAK™ Radio/Utility Case

4280384F89 Universal RadioPAK™ Belt Lengthener; fits waists larger than 40"



RLN4815A

Audio Accessories

Remote Speaker Microphone (RSM)

Allows you to talk and listen without removing the radio from the belt, case or charger. Ideal for high noise level environments. This water resistant compact unit has a coiled cord, PTT switch and back cover clip.

***NMN6217B** Remote Speaker Microphone with 6" Coil Cord



NMN6217B

Public Safety Microphone (PSM)

NMN6227B 30" Public Safety Mic with Straight

NMN6234B 24" Public Safety Mic with Straight Cord

NMN6236B 18" Public Safety Mic with Straight Cord

Note: The public safety speaker/mic is not compatible with Saber or System Saber radios and is not recommended for the use with VHF. Antennas are not included with the public safety speaker/mic. The public safety speaker/mic utilizes the same antenna as the Astro Saber

NTN5581A Thumbscrew for Standard Screw Replacement



NMN6236B

RSM and PSM Accessories

Antennas for PSM

8505309N09 400-430 MHz

8505309N10 440-470 MHz

8505309N11 470-512 MHz

Velcro Patch

NLN8410A Velcro Patch Pin Attachment for Speaker/Microphone Assemblies

* *Intrinsically safe*

ASTRO Digital SABER Series

Portable Accessories

Audio Accessories



RLN4295A

Epaulet Strap

Black leather epaulet straps secure remote speaker microphones to epaulet of shirts or jackets and attach around cord to back of microphone.

RLN4294A Epaulet Strap, Velcro

RLN4295A Epaulet Strap, small clip

Miscellaneous Connector Cover

NTN7061A Universal Connector Cover



NTN7061A

CommPort: Integrated Microphone/Receiver System

The CommPort system contains a miniature microphone and receiver, and connects to your two-way radio, making it possible to hear and speak under the most adverse conditions. Astro Digital Saber Radios require 4305909W01 coaxial antenna connector; must be ordered separately.

***NTN1623A** Integrated Ear Microphone/Receiver System with Palm PTT, includes NTN5664A Hirose adapter.

***NTN1721A** Integrated Ear Microphone/Receiver System with Ring PTT, includes NTN5664A Hirose adapter.

***NTN1738A** Intergrated Ear Microphone/Receiver System with Snap-on Side PTT; includes NTN5664D adapter

NNTN4185A Integrated Microphone/Receiver System with Remote Push-to-Talk Body Switch; includes NTN5664A Hirose adapter



NTN1623A

Audio Accessories

NKN6526A Replacement Snap on side PTT Cable for NTN1738A

NKN6507A Replacement Palm PTT Cable for NTN1623A

NKN6524A Replacement Ring PTT Cable for NTN1721A

NNTN4189A Replacement Remote Push-To-Talk Body Switch

NTN8821A CommPort Maintenance Kit, includes replacement ear tubes (quantity 10), windscreens (quantity 2) and microphone seal strips (quantity 10)

NTN8986A Adhesive Pads (quantity 90) for secure attachment to ear

NTN8988A Ear Straps (quantity 10), for secure attachment to ear

RLN5037A Replacement Ear Tubes (Quantity 10)

4285838B01 Replacement Collar Clip

4202006A01 Replacement Back Cover Clip

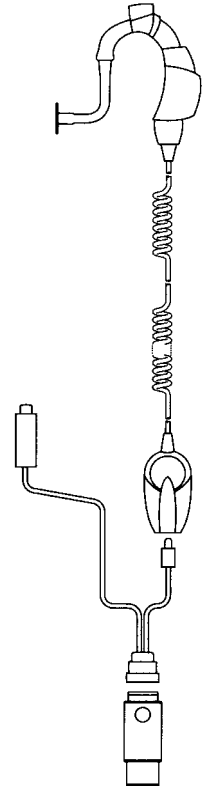

NTN1623A

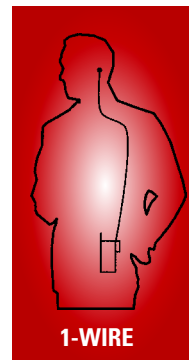

1-WIRE

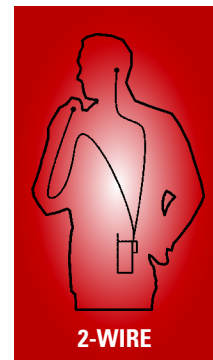

2-WIRE

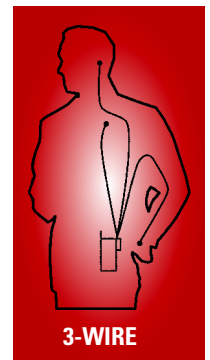

3-WIRE

* Intrinsicly Safe



ASTRO Digital SABER Series

Portable Accessories

Audio Accessories

Surveillance Kits

Surveillance accessories allow the user to privately receive communications with the earpiece and are ideal when environments require discreet communications.

The following Surveillance Kits require NTN5664D adapter.



ZMN6032A

NSN6050A Surveillance Kit, Receive-only (1-Wire Kit)

***ZMN6032A** Surveillance Kit with Microphone and PTT Combined (2-Wire Kit)

***ZMN6031A** Surveillance Kit with Microphone and PTT Separate (3-Wire Kit)



ZMN6031A

*†**ZMN6038A** Surveillance Kit with Microphone and PTT Combined, Extra Loud Earpiece (exceeds OSHA limits) (2-Wire Kit)

*†**ZMN6039A** Surveillance Kit with Microphone and PTT Separate, Extra Loud Earpiece (exceeds OSHA limits) (3-Wire Kit)

NTN5664D Surveillance Accessory Adapter (with keyload capability). Requires Astro Antenna Adapter, 4305909W01 (order separately.)

Audio Accessories

Noise Kits



NTN8370A

Lightweight translucent tube attaches to Motorola surveillance accessories. Clothing clip prevents the accessory from being pulled from the ear due to body movement or head rotation.

NTN8370A Extreme Noise Kit, includes 2 foam earplugs for loud environments, provides 24dB of noise reduction

NTN8371A Low Noise Kit; includes rubber eartip for low noise environments, does not provide hearing reduction

5080384F72 Replacement Foam Plugs; pack of 50 (for use with NTN8370A)

5080371E73 Beige Replacement Standard Rubber Eartips; for use with NTN8371A, (pack of 25)

5080371E75 Black Replacement Standard Rubber Eartips; for use with NTN8371A, (pack of 25)

Clear Comfortable Earpiece

The clear comfortable earpiece forms to the inside of your ear and is perfect for low noise environments. Compatible with the NTN8371A, clear acoustic tube assembly, and most surveillance kits (1-, 2- and 3-wire). This earpiece is made of easy-to-clean chemically inert, hypoallergenic material. Does not provide hearing protection.

There are 3 items needed to make this product work:

1. Clear Comfortable Earpiece
2. Clear Acoustic Tube Assembly (NTN8371A)
3. Surveillance Kits

RLN4760A Small Custom Earpiece, right ear

RLN4763A Small Custom Earpiece, left, ear

RLN4761A Medium Custom Earpiece, right ear

RLN4764A Medium Custom Earpiece, left ear

RLN4762A Large Custom Earpiece, right ear

RLN4765A Large Custom Earpiece, left ear

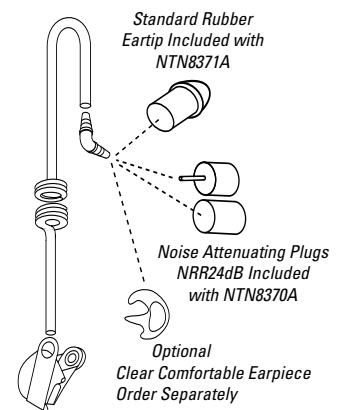

Acoustic Tube with Earphone

* Intrinsicly Safe

† Extra Loud Earpiece (exceeds OSHA limits)

ASTRO Digital SABER Series

Portable Accessories

Surveillance Accessories

Ear Microphone System (EMS)

This compact unit picks up the voice through bone vibrations in the ear canal. The miniature earpiece leaves the hands free and face unobscured when worn by rescue and hazard protection personnel, who still retain the ability for direct hearing and speaking. For personnel required to wear breathing apparatus, communications with protective masks are as clear as communications without. And its high speech clarity under noisy environments makes it ideal for high noise environments. Available in PTT or Voice Activated (VOX). Interface Module needs to be ordered separately for EMS to work.



BDN6641A
Requires
interface module,
sold separately

***BDN6677A** Ear Microphone for standard noise levels (up to 95 db), black

***BDN6678A** Ear Microphone for standard noise levels (up to 95 db), beige

***BDN6641A** Ear Microphone for high noise levels (up to 105 db), grey

Interface Modules For EMS



BDN6643B

***BDN6642B** Push-To-Talk Only Interface Module

***BDN6643B** Push-To-Talk and Voice-Activated Interface Module

Optional Accessories for EMS

0180300E25 Earguard with Adjustable Loop

0180358B38 Remote Push-To-Talk Ring Switch

Audio Accessories

0180300E83 Remote Push-To-Talk Body Switch

0180358B32 Earholder, Black, Size Small; secures ear mic in ear

0180358B33 Earholder, Black, Size Medium; secures ear mic in ear

0180358B34 Earholder, Black, Size Large; secures ear mic in ear



0180300E83



0180358B33

0180358B35 Earholder, Clear, Size Small; secures ear mic in ear

0180358B36 Earholder, Clear, Size Medium; secures ear mic in ear

0180358B37 Earholder, Clear, Size Large; secures ear mic in ear

4280369E44 Replaceable Belt Clip with Screws

5080358B28 Eartips, Black, Size Medium (10 per pack)

5080358B29 Eartips, Black, Size Large (10 per pack)

5080358B30 Eartips, Beige, Size Medium (10 per pack)

5080358B31 Eartips, Beige, Size Large (10 per pack)

Lightweight Headsets

Lightweight headset allows for high clarity, hands free, discreet two-way communications while adding comfort for extended wear in moderate noise environments.

***NMN6050B** Lightweight Headset with Boom Microphone, to be worn on a helmet or safety glasses; requires NTN5913A adapter cable

***NTN5913A** Headset Adapter Cable with Bayonet Jack

* Intrinsicly Safe



ASTRO Digital SABER Series

Antennas

Audio Accessories

Heavy Duty Headsets

Heavy duty headsets include noise canceling boom microphones and can be worn with or without a hardhat. Headsets are for use in noise levels up to 125dB. The Push-to-Talk switch is located on the earcup. The VOX module is contained within the headset on voice activated units. Heavy duty headsets require radio adapter cable to be ordered separately.

BDN6645A Push-To-Talk Headsets with Boom Microphone; requires adapter cable BDN6640A; noise reduction rating =24dB



BDN6645A



BDN6635B

BDN6635B Voice Activated (VOX) Headset with Boom Microphone; requires adapter cable BDN6640A; noise reduction rating =24dB

***BDN6636B** Voice Activated (VOX) Headset with Throat Microphone; requires adapter cable BDN6640A; noise reduction rating =24dB



BDN6636B

***BDN6640A** Radio Adapter Cable

* Intrinsicly Safe

Portable Antennas

Heliflex Antennas

Motorola Heliflex antennas are specifically engineered for maximum output and greatest communication coverage.

VHF Band

8505644V01

Helical 136-150.8 MHz

8505644V02

Helical 150-162 MHz

8505644V03

Helical 162-174 MHz

8505518V01

Helical 136-174 MHz

UHF Band

8505644V04

Helical 403-433 MHz

8505644V05

Helical 435-470 MHz

8505644V06

Helical 470-520 MHz



8505644V01



8505644V03



8505644V04

ASTRO Digital SABER Series

Antennas, Batteries

Portable Antennas

Flexible Whip Antenna

Flexible Whip antennas have a one-piece finish and steel core for optimal radiation characteristics. Provides more comfort when radio is worn on the belt.

8505241U05

Flexible Whip, 403-520MHz, 6"

8505241U03

Flexible Whip, 806-869MHz, 7"

Dipole Antennas

Dipole molded antennas are injection molded in lasting polyurethane. The wide skirt at the bottom of the connector protects against damaging environmental elements. The dipole antenna is ideal when strong and solid signal clarity is demanded.

NAF4000B Dipole, 806-869MHz, 8"

Stubby Antenna

This stubby quarterwave antenna is ideal when radio is worn on the belt because the short antenna is non-obtrusive.

***8505241U06** Stubby, 806-941MHz, 4"



8505241U05



NAF4000B



8505241U06

Portable Batteries

Nickel-Cadmium Premium

Part Number: **NTN4593DR**

Volts: 7.5

Avg. mAh: 1100

Height: 3-1/4"

Intrinsically Safe: No

Part Number: **NTN4595DR**

Volts: 7.5

Avg. mAh: 1800

Height: 4"

Intrinsically Safe: No

Part Number: **NTN4657AR**

Volts: 7.5

Avg. mAh: 1100

Height: 4"

Intrinsically Safe: No

CSA: Yes

Part Number: **NTN4538DR**

(Submersible)

Volts: 7.5

Avg. mAh: 1100

Height: 3-1/4"

Intrinsically Safe: Yes

Part Number: **NTN4596DR**

(Submersible)

Volts: 7.5

Avg. mAh: 1800

Height: 4"

Intrinsically Safe: Yes



NTN4596DR

* 8505241U06 is a broad band antenna that operates in the 800/900MHz band

ASTRO Digital SABER Series

Batteries

Portable Batteries

Part Number: **NTN4992CR**
(Submersible)

Volts: 7.5
Avg. mAh: 1800
Height: 4"
Intrinsically Safe: Yes

Part Number: **NTN7058AR**
(Submersible/
Ruggedized)

Volts: 7.5
Avg. mAh: 1800
Height: 4"
Intrinsically Safe: Yes



NTN7058AR

Nickel Metal Hydride Premium

Part Number: **NTN7014BR**

Volts: 7.5
Avg. mAh: 950
Height: 3-1/4"
Intrinsically Safe: No

Part Number: **NTN8251AR**

Volts: 7.5
Avg. mAh: 1650
Height: 3-1/4"
Intrinsically Safe: Yes

Portable Batteries

Lithium-ion Premium

Part Number: **NTN8818A**

Volts: 7.2
Avg. mAh: 1700
Height: 2-3/8"
Intrinsically Safe: No

Nickel-Cadmium impres™

To maximize impres battery features and benefits, an impres charger must be used.

Part Number: **HNN9033AR**

Volts: 7.5
Avg. mAh: 1800
Height: 4"
Intrinsically Safe: No

Part Number: **HNN9034AR**

Volts: 7.5
Avg. mAh: 1800
Height: 4"
Intrinsically Safe: Yes



HNN9033AR

ASTRO Digital SABER Series

Service Aids, Manuals

Service Aids

Battery Eliminator

The battery eliminator acts like a battery with a cable to access a DC external power supply. It is ideal to inspect transmitters and receivers on incoming radios. Reverse supply polarity protection and input fuse protection are provided.

RTL4224A Battery Eliminator

Torque Screwdriver

Measure the amount of torque being applied. Built-in magnified dial. Calibrations clearly marked.



RSX4043A Adjustable Torque Screwdriver

6680321B79 Torque Bit, for Power Contact Screws

6680321B86 Torque Bit, for Controller Shield Screws

6680370B88 Torque Bit, for 16 Position Select or Switch Spanner Nut

6680370B89 Torque Bit, for Slotted-Spanner Baseplate Nut

6680371B03 Torque Bit, for Frequency Switch & Volume Pot Spanner Nut

6680371B34 Torque Bit, for RX/TX Switch Spanner Nut

Housing Eliminator

REX4200A Housing Eliminator

Adapter

5880384G68 SMA to BNC RF Adapter



Radio Test and Programming Cable

Used with portable radio test set, RTX4005B, for transmitter, receive alignment and performance checks. Also used in programming radio.

RKN4046A Radio Interface Box/Radio/Test Set Cable

Service Aids

Radio Service Software

Utilizing your personal computer, this software enables you to add or reprogram frequencies as your requirements change. IBM 366 is recommended for these products. Requires interface box and appropriate cables.

RVN4100P Programming Software

Radio Interface Box

Links radio programming cable and computer interface together. Provides required voltage shift to enable communications between radio and computer. Requires computer and interface cable, radio test and programming cable, and 9 volt snap type battery (6082728J01).



RLN4008E Radio Interface Box

0180357A57 AC Power Pack, 110V

0180358A56 AC Power Pack, 220V

3080369B71 IBM to RIB Cable, 25 Pin

3080369B72 IBM to RIB Cable, 9 Pin

Manuals

0180305J46 Ear Microphone System and Temple Transducer CD-ROM

0180305J70 impres™ System CD-ROM

6881076C05 Basic Service Manual

6881076C10 Detailed Service Manual

6881072C75 ASTRO Digital SABER I VHF, UHF, 800 MHz Operator/User's Manual

6881072C80 ASTRO Digital SABER II, III, VHF, UHF, 800 MHz Operator/User's Manual

6881098E85 ASTRO Digital SABER VHF, UHF, 800 MHz Radio Service Software Manual